

Collector arms (with flat connection terminals)

Collectors can be easily connected and disconnected to/from lead wires with just one motion.

Mount rod and mount plate types are available to fit mounting hardware.

Note: UL certification not yet obtained.

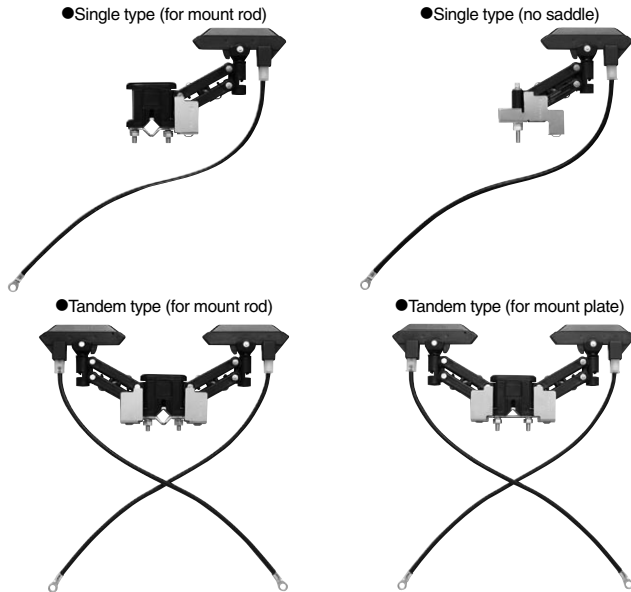

The collector arms should be replaced when it wears down to the replacement indication line. Typical collector service life is approximately 20,000km. Length of lead wire 300mm

Cat. No.	Type	Rating	Weight (kg)	Units per box	Units per carton
DH56931K1	Single (for mount rod)	1P600V20A	0.14	1	16
DH56941K1	Tandem (for mount rod)	1P600V20A×2	0.23	1	16
DH56942K1	Tandem (for mount plate)	1P600V20A×2	0.23	1	16
DH56950K1	Single (no saddle)	1P600V20A	0.11	1	16

Collector arm support hardware

These components are mounted on the collector arm. They keep the arm horizontal and minimize uneven abrasion of the collector shoe. It is also possible to mount them on existing collector arms.

Note: UL standards do not apply.

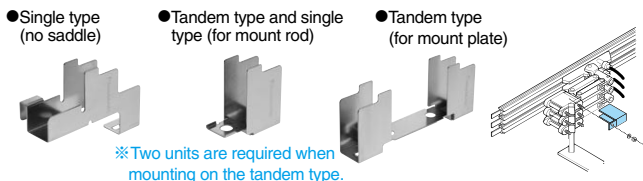

Cat. No.	Type	Weight (kg)	Units per box	Units per carton
DH58870	Single (no saddle)	0.013	12	120
DH58871	Tandem, Single (for mount rod)	0.007	12	120
DH58872	Tandem (for mount plate)	0.017	12	120

Collector (replacement part)

Note: UL standards do not apply.

Note: This collector is a replacement part for using collector arms which are of an earlier type than the collector arms listed on page 25 of this catalog.

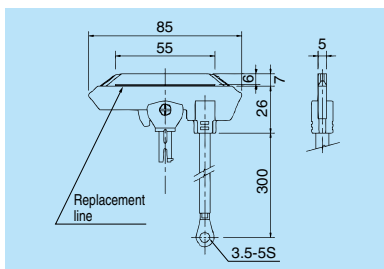

Length of lead wire 300mm

Cat. No.	Rating	Weight (kg)	Units per box	Units per carton
DH5883K3	1P600V30A	0.06	10	100

●Single type (for mount rod)

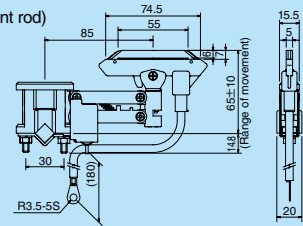

●Tandem type (for mount rod)

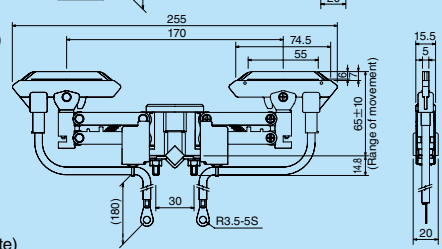

●Tandem type (for mount plate)

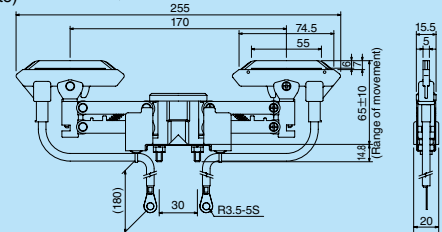

●Single type (no saddle)

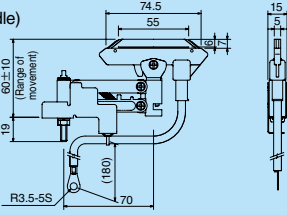

Conductor cleaner

This nylon brush is used to clean the conductor surface of the High-Tro-Reel units.

Note: UL standards do not apply.

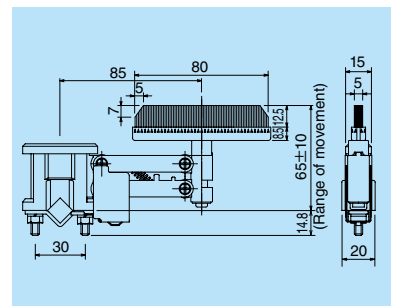

Cat. No.	Type	Weight (kg)	Units per box	Units per carton
DH56851K1	Single (for mount rod)	0.12	1	16

Collector (with flat connection terminals; replacement part)

Collectors can be easily connected and disconnected to/from lead wires with just one motion.

Note: UL standards do not apply.

Note: This collector is a replacement part for using with collector arms which are of an earlier type than the collector arms listed on page 26 of this catalog.

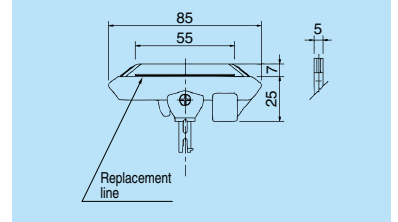

Cat. No.	Rating	Weight (kg)	Units per box	Units per carton
DH5684K2	1P600V20A	0.12	10	100